



Pro-V Series

Programmable Digital Thermostats
With Modulating FAN control

OPERATION MANUAL

Index

<u>Content</u>	<u>Page</u>
INSTALLATION	3
MOUNTING ON ELECTRIC BOX	3
MOUNTING FRONT COVER	3
WIRING EXAMPLE	3
OPERATION	4
SETTING CLOCK	7
SETTING PROGRAM FUNCTION	7

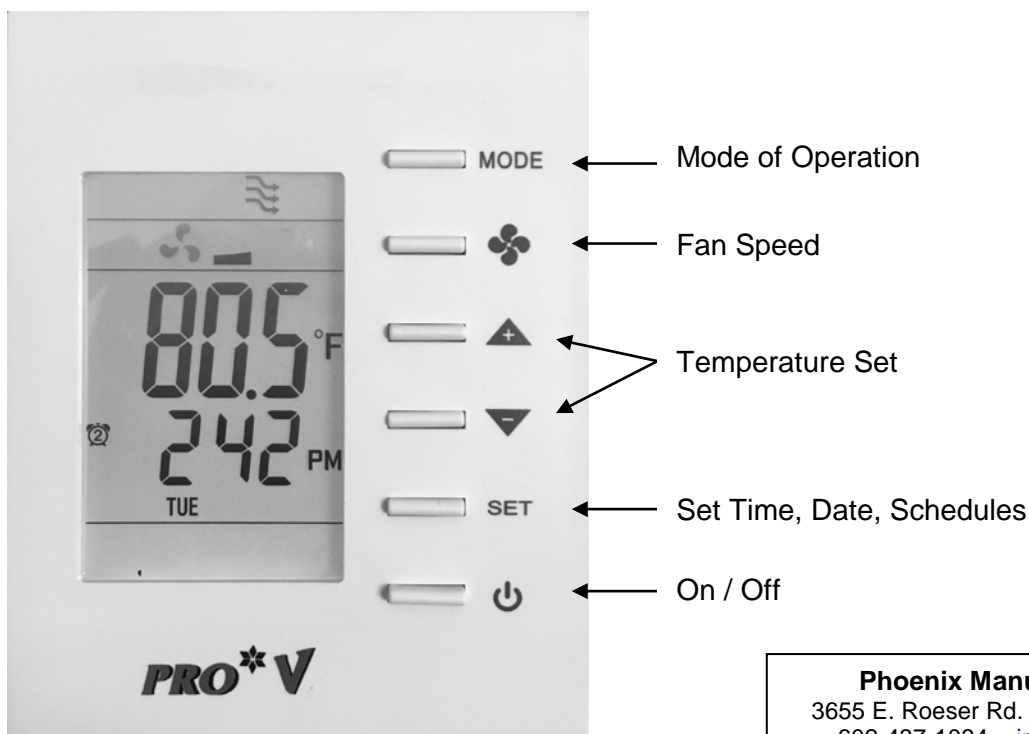

Phoenix Manufacturing Inc.
3655 E. Roeser Rd. – Phoenix, AZ 85040
602-437-1034 - info@evapcool.com
01-999-2578

Front view

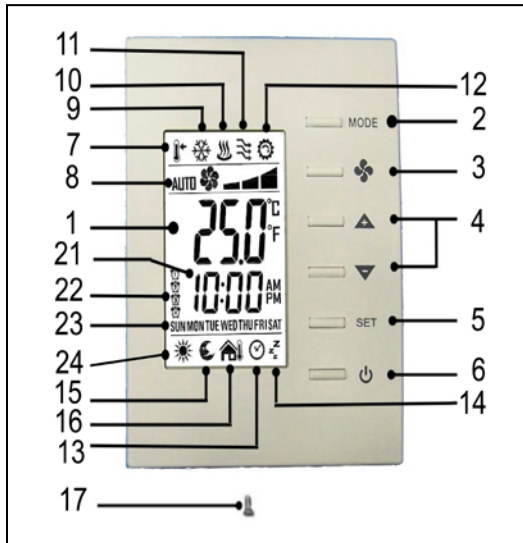

Back view

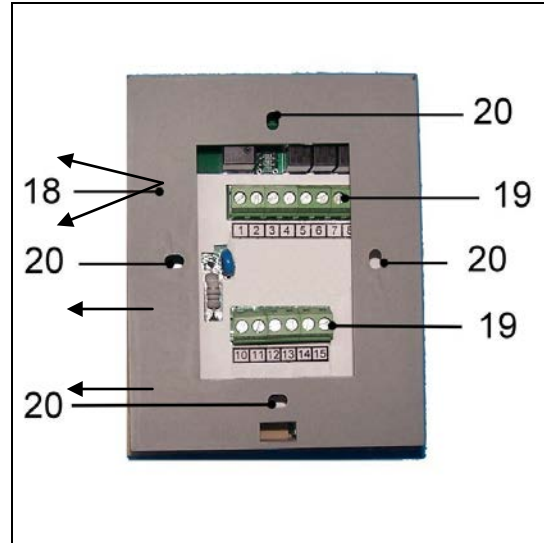

#	Item	Description
1	LCD	Display temperature and working status.
2	MODE button	Access to user and engineer menu and for setting confirmation or change °C/°F unit if press for over 3 sec.
3	FAN button	Toggle to change Fan mode: Auto or cont. Low/ Hi
4	UP & DOWN buttons	Increase & decrease setting or previous/next item
5	SET button	Setting for schedules and Timers
6	On/Off button	Turn on/ off thermostat
7	Set-point icons	Displaying set-point temperature while it is flashing
8	Fan icons	Indicate Fan status
9	Snow Flake icon	Indicate working on Cooling mode; Flashing = Pre-wet
10	Hot spring icon	Indicate working on Heating mode (NA)
11	Flow icon	Indicate working on ventilating mode
12	Gear icon	Indicate cooler is ON
13	Clock	Indicate current System ON or OFF was enabled by real time Timer.
14	Sleep	(NA)
15	Moon Sign	Indicating room is unoccupied or Vacation Mode
16	Outdoor icon	Indicating door/ window is open(NA)
17	Cover screw	Screw to tighten back cover with front cover
18	Back plate	Plate for mounting on electric box
19	Wiring terminal blocks	Terminals for wiring
20	Mounting holes	Holes for mounting on electric box
21	Clock	Display time
22	Schedule number	Current Schedule running or setting
23	Day	Current day of Sunday ~ Saturday or setting
24	Sun	Indicate Drain is undergoing now

Installation

Note: This unit requires at least 6 conductor thermostat wire. 18-6 is recommended.

Mounting on electric box

1. Separate back plate from the controller by loosening the cover screw;
2. Align the mounting holes on the screw holes of the electric box (applicable to 65x65 or US standard box);
3. Fix the back plate on the electric box by tightening the back plate screws. Suggest using Philips drive "truss head" or "washer head" #6-32x 3/4" (20mm).
4. DO NOT let the bolt head rise above the wall of mounting holes of back plate. It might cause the short circuit of the controller.

Mounting front cover

1. Lock front cover on the back plate by tightening the cover screw underneath with Philips head screw driver.

Wiring Example

All wires coming from electric box must be inserted above the retainers of respective terminal block before tightening the captive screws

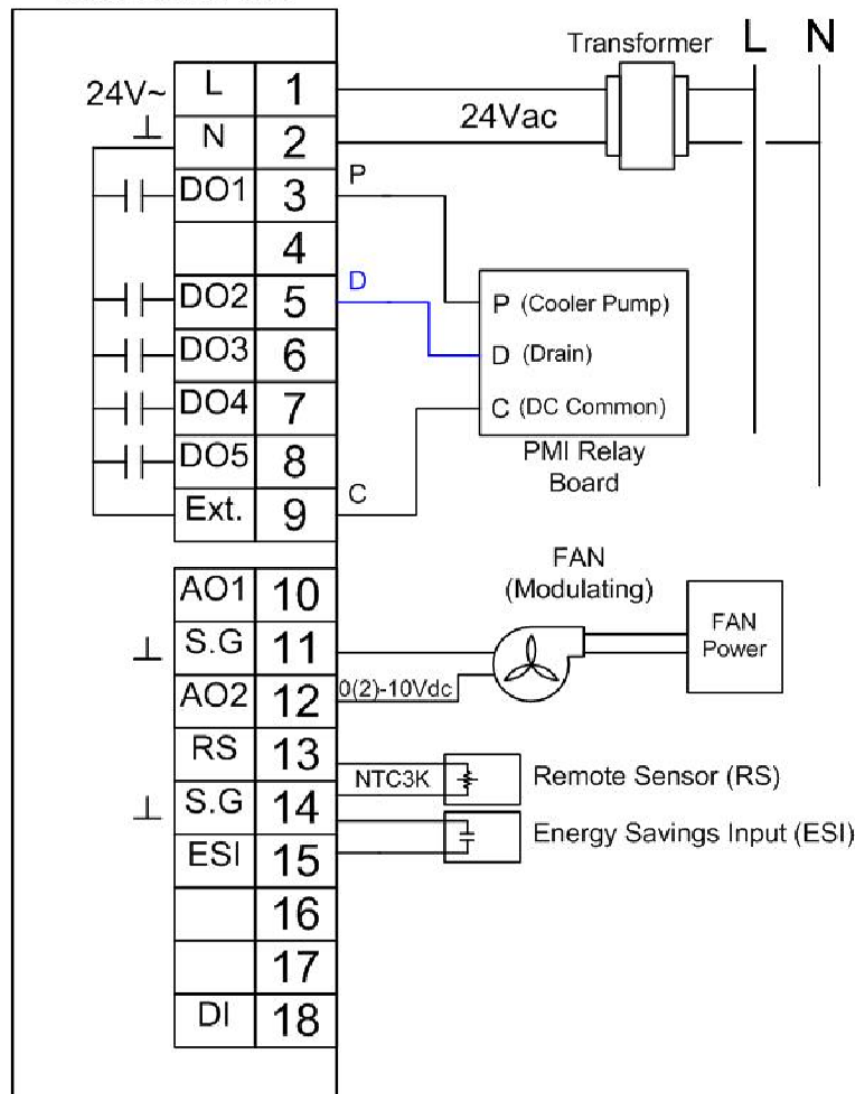





Operation

User Mode Operation

The first tier of operation includes the following settings as Figure 2. To operate:

1. Power switch  "ON" or "OFF" to start/ stop the System;
2. After switching "ON", press any button to start the User Mode operation.
 - i. Press "MODE" button to switch over different working modes. When MODE is pressed for more than 3 seconds, the unit of temperature will toggle to change to °F or °C.
 - ii. Press UP/ DOWN button to increase/ decrease or rotate the values of setting.
 - iii. Press "FAN" button to toggle over different fan modes. When FAN is pressed for more than 3 seconds, it will activate "DRAIN" command to start drain pump for 1 1/2 minutes.
 - iv. Press "SET" button to set current time-date and timer. When SET is pressed for more than 3 seconds, users can set the set points schedules.
3. It will return to normal display with the latest setting if there's no button pressed for 10 seconds.

#	Item	Description	Remarks
1	Normal Display	Display current room or set-point temperature and current time-day.	Setting "-SP-"parameter in Engineer table to choose Current room or Set-point temperature.
2	Temperature Setting 	Set the required temperature	
3	Mode Select 	1. Select the working mode: (1) Cool/ AirC for Cooling or Ventilating. (2) run/ Ovr/ HAnd for schedule 2. When MODE is pressed for more than 3 seconds, the unit of temperature will toggle to change to °F or °C.	RUN means Running Schedules. Ovr (override) means temporarily using manual S.P and skip "current" Schedule. HAnd means using manual S.P instead of "all" Schedules.
4	Fan Auto/ Continuous 	1. Change Fan mode for Auto speed or manual Low/ Hi speed. 2. When FAN is pressed for more than 3 seconds, it will activate "DRAIN" command to start drain pump for 1.5 minutes.	
5	Time/ Date/ Schedule Setting 	1. Set current time in 12- or 24-hour format; 2. Set calendar and day of week; 3. When SET is pressed for more than seconds, users can set temperature set points schedules	Press SET to continue settings. Press MODE, FAN, or POWER button to escape any time during setting.

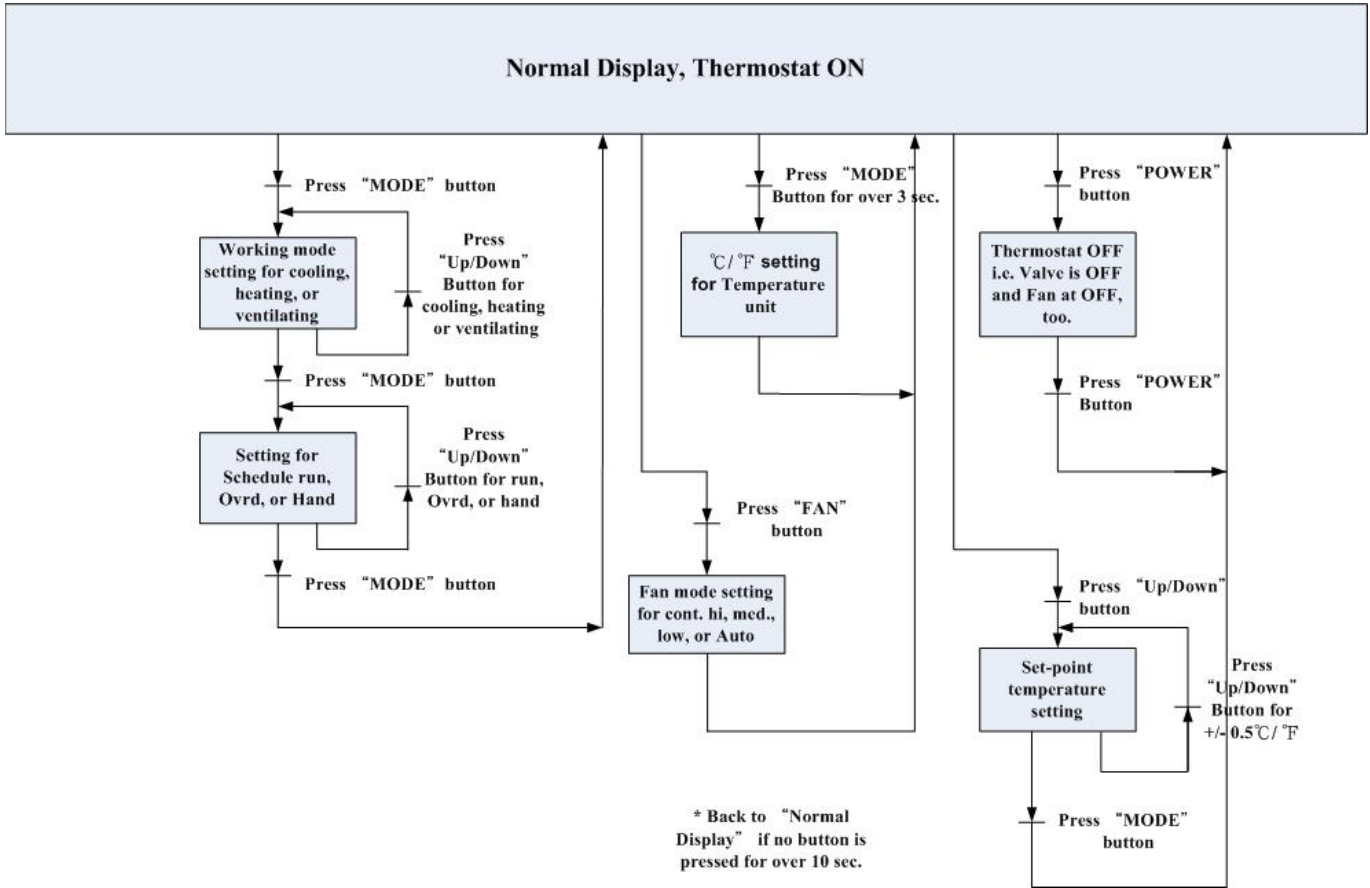
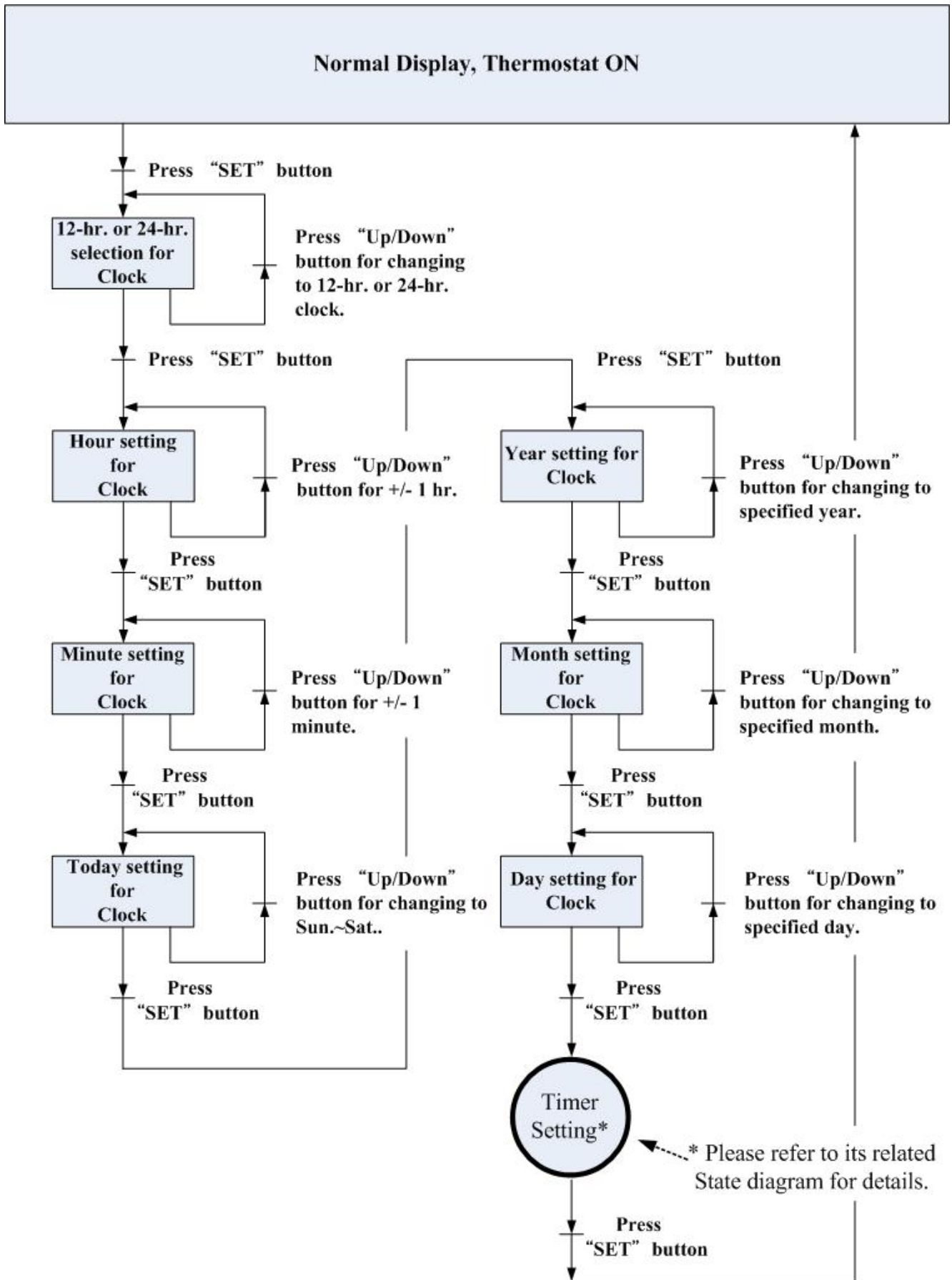
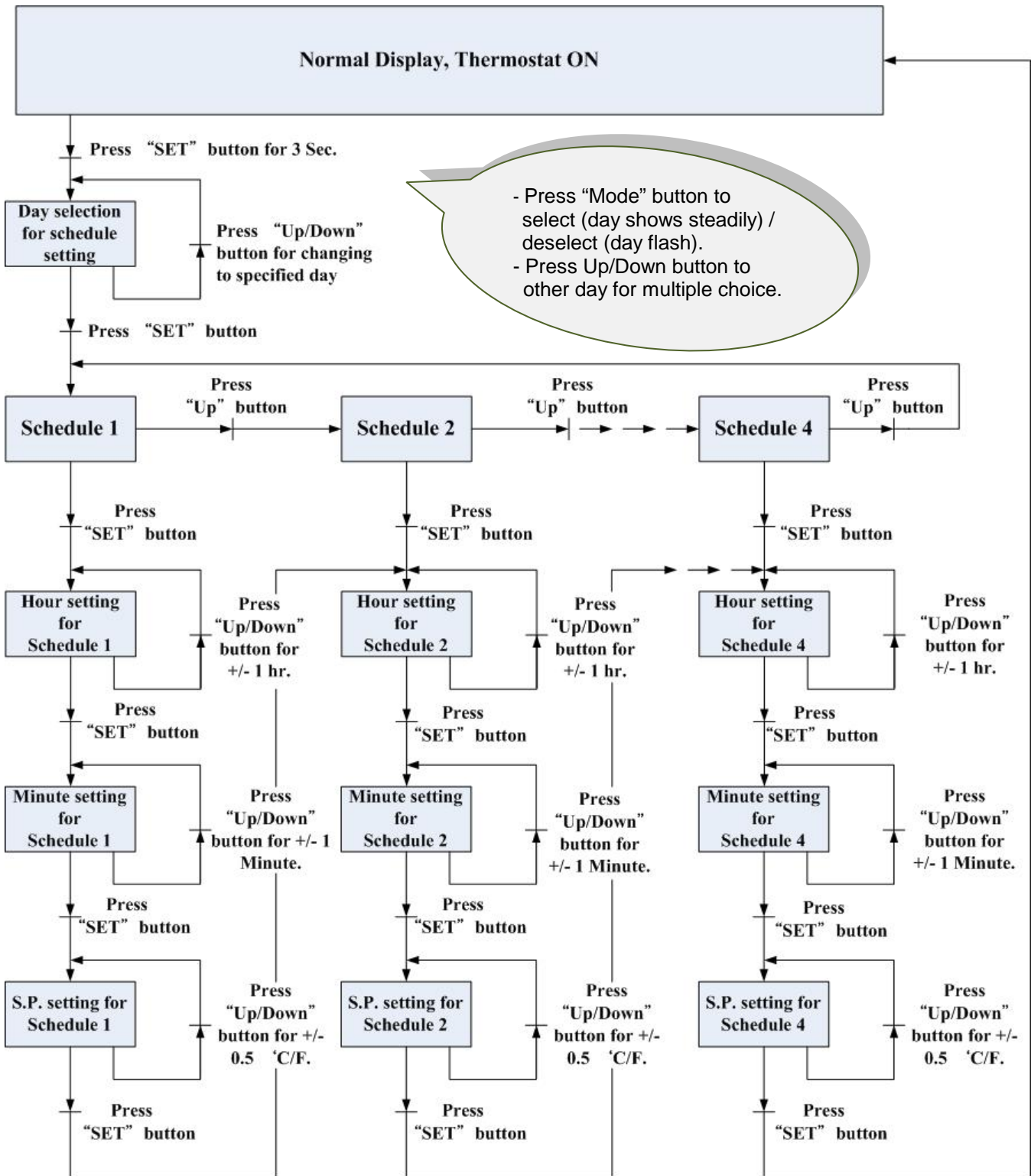

Fig. 2 User Mode operation sequence

1. Detailed State Diagram for Clock Setting







2. Detailed State Diagram for Schedule Setting







Example of Setting Table for Schedules

Table of Set-point temperature for each Schedule will be like this (Ex.: if wants 6:00 79.0°F, 8:00 85.0°F, 18:00 79.0°F, and 22:00 79.0°F every day):

	Sun	Mon	Tue	Wed	Thu	Fri	Sat
Sch. 1 	6:00 Cool:79.0°F / 26.0°C	6:00 Cool:79.0°F / 26.0°C	6:00 Cool:79.0°F / 26.0°C	6:00 Cool:79.0°F / 26.0°C	6:00 Cool:79.0°F / 26.0°C	6:00 Cool:79.0°F / 26.0°C	6:00 Cool:79.0°F / 26.0°C
Sch. 2 	8:00 Cool:85.0°F / 29.5°C	8:00 Cool:85.0°F / 29.5°C	8:00 Cool:85.0°F / 29.5°C	8:00 Cool:85.0°F / 29.5°C	8:00 Cool:85.0°F / 29.5°C	8:00 Cool:85.0°F / 29.5°C	8:00 Cool:85.0°F / 29.5°C
Sch. 3 	18:00 Cool:79.0°F / 26.0°C	18:00 Cool:79.0°F / 26.0°C	18:00 Cool:79.0°F / 26.0°C	18:00 Cool:79.0°F / 26.0°C	18:00 Cool:79.0°F / 26.0°C	18:00 Cool:79.0°F / 26.0°C	18:00 Cool:79.0°F / 26.0°C
Sch. 4 	22:00 Cool:79.0°F / 26.0°C	22:00 Cool:79.0°F / 26.0°C	22:00 Cool:79.0°F / 26.0°C	22:00 Cool:79.0°F / 26.0°C	22:00 Cool:79.0°F / 26.0°C	22:00 Cool:79.0°F / 26.0°C	22:00 Cool:79.0°F / 26.0°C

Note: If set a Schedule's time as "--:--" instead of a specified time, it means disable this Schedule.

P.S.: The icon , , , or  will be shown on LCD steadily while the Schedule 1,2,3, or 4 is running.

Control Action

1. Cooler and Fan Controls:

When cooler is on, a "Running (Gear) ()" icon will be shown on the LCD.

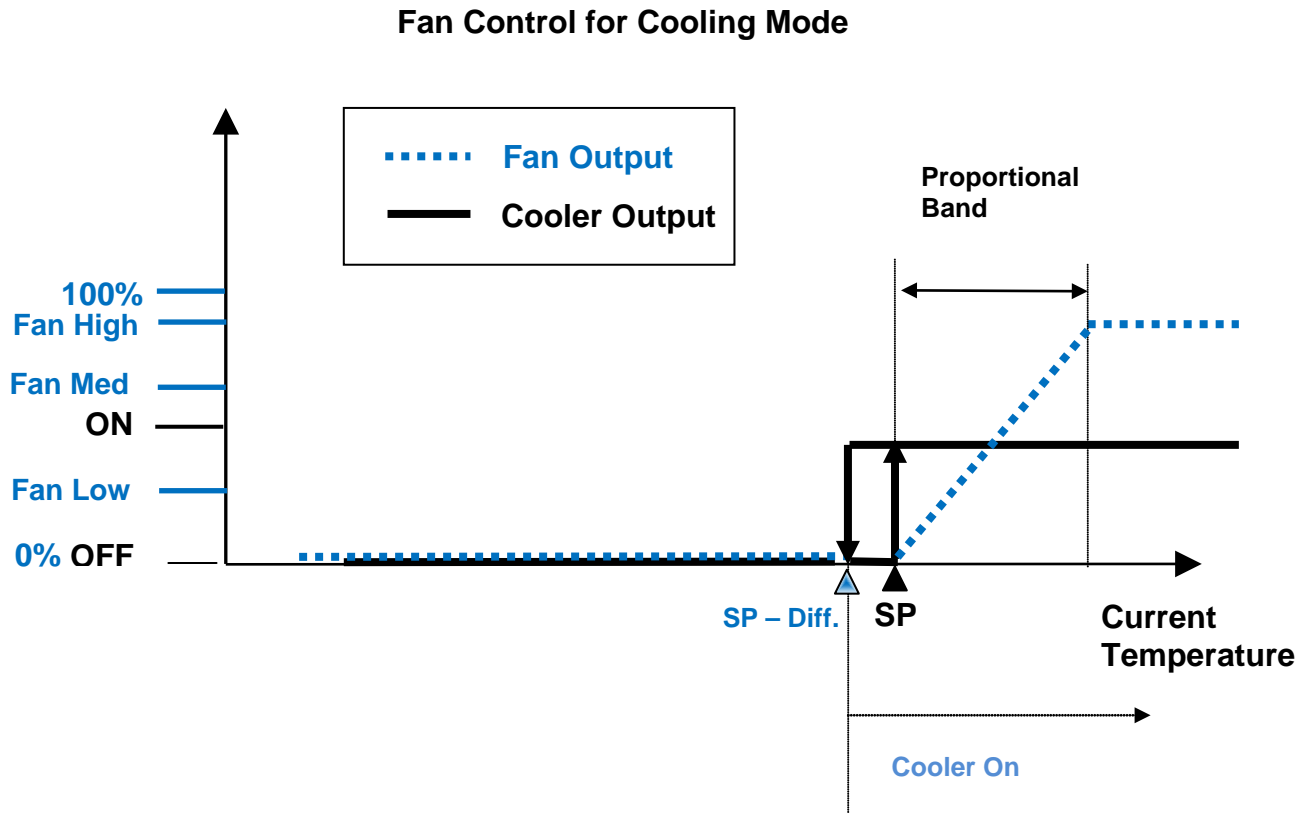

2. Pre-wet Action:

Pre-Wet will happen when the cooler pump is off for 10 minutes or more and call for cooling as the above control diagram.--- If need to do Pre-wet, when the room/space temperature reach SP or above, the cooler pump will be on for 1 minute only (i.e. no Fan). This action is called Pre-wet. And after Pre-wet finish, the Fan will return back to appropriate speed.

During Pre-wet period, the icon of ice flake  will flash to indicate pre-wetting is in action.

Pre-wet might be postponed until drain action finished.

3. Drain Action:

(1) **Automatic Drain:** Every accumulative 4 hours(default and 2, 4, 6, 8, or 0(OFF) hours selectable) of cooler pump operation will start drain pump for 2 minutes(default, and 2, 5 or 9 minutes selectable).

(2) **Manual Drain:** Press FAN push button for more than 3 seconds will command drain pump to activate for 1.5 minutes. It will reset the timed circulating cooler pump operation counter. This can be done even at system OFF but not executed during Pre-wet period.

During dwell time, the icon of SUN  will be shown to indicate drain is in action.







4. Fan Controls:

(1) **Vent Mode:** Press FAN push button to set AUTO/ LOW/ MED/ HIGH fan speed. The respective modulating output can be set for each manual speed.

(2) **Cool Mode:** Press FAN push button to set AUTO/ LOW/ MED/ HIGH fan speed. The respective modulating output can be set for each manual speed.

(3) For Auto fan speed, Low/ Med/ High fan bar will appear when fan speed reaches the set output respectively.

Special:

1. ESI (Energy Saving Input) Contact status -- When the contact is activated (Vacation or Room unoccupied), a "Moon (☾)" icon will be shown on the LCD and the thermostat will change the set-point temperatures of Cooling & Heating to be ESIC & ESIH (refer to Engineer table for details.). When the contact is deactivated (Room back to be occupied), it will set the set-point values back as normal.
2. If disable local ESI contact detection, the room will become always occupied status as default.
3. The icon , , , or  will be shown on LCD while the Schedule 1,2,3, or 4 is running or being set.
4. If press "MODE" button, there are three schedule modes "RUN, Ovr, and HAnd" for selection.
 - a.) RUN mode means Running on Schedules. And at the same time, an icon () will be steadily shown on the LCD.
 - b.) Ovr (override) mode means temporarily using manual S.P instead of "current" Schedule. And the icon () will be flashing on the LCD.
 - c.) HAnd mode means using manual S.P instead of "all" Schedules. i.e. Temporarily disable all schedules. And the icon () will be NOT shown on the LCD.